

ermes 48V

P R E V I E W 2 0 2 4

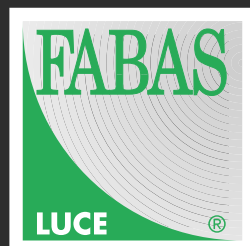

AULIX lighting

návrhy osvětlení a prodej svítidel
inteligentní systémy, vypínače

SVĚTELNÉ STUDIO

Náměstí Na Sádkách 705
252 41 Dolní Břežany (Praha západ)

Telefon: +420 246 083 152

Mobil.: +420 702 061 783

E-mail: studio@aulix.cz

Web: www.aulix.cz

E-shop: <http://obchod.aulix.cz>

Sledujte nás také na sociálních sítích:





linea ermes 48v



Fabas Luce concretizza la sua pluriennale esperienza nei settori tecnico e decorativo realizzando la nuova linea ERMES 48V che in un sistema riunisce i contenuti tecnologici e l'estetica del design minimale decorativo.

La collezione 48V vuole essere una soluzione flessibile e variegata sia in termini di strumenti ottici che di possibilità compositiva. Binario elettrificato a bassissima tensione, 48V DC, impiegabile in sospensione, a parete o a soffitto oppure, nella versione trimless, incassato nei controsoffitti. Realizzato in estruso d'alluminio verniciato a polvere, disponibile nelle misure 1m, 2m o 3m nei colori bianco o nero completo di angoli orizzontali e verticali. L'alimentatore prevede le funzionalità ON/ OFF e DALI da installare in remoto o integrato nel sistema. Una estrema flessibilità progettuale è garantita dalla **gamma di prodotti disponibili che sono tutti compatibili con i binari EVO STUCCHI**: schermo opale per l'illuminazione generale, multicella per le soluzioni a luminanza controllata, e un'ampia gamma di

Fabas Luce concretises its many years of experience in the technical and decorative sectors by creating the new ERMES 48V line, which in one system brings together the technological contents and aesthetics of minimal decorative design.

The 48V collection aims to be a flexible and varied solution both in terms of optical instruments and compositional possibilities. Very low voltage electrified track, 48V DC, can be used suspended, on the wall or ceiling or, in the trimless version, recessed into false ceilings. Made of powder-coated extruded aluminium, available in 1m, 2m or 3m sizes in white or black complete with horizontal and vertical corners. The ballast provides ON/OFF and DALI functionality to be installed remotely or integrated into the system. Extreme design flexibility is ensured by **the range of products available, all of which are compatible with EVO STUCCHI tracks**: opal screen for general lighting, multi-cell for controlled luminance solutions, and a wide range of adjustable spots with high quality CRI90 LEDs, in different powers and optics.



spot orientabili con led di alta qualità CRI90, in diverse potenze e ottiche. Ermes è pensato per ogni contesto in cui la luce si rivela in modo discreto, perfetto per il mondo dell'arte e per il retail, si integra in qualsiasi tipo di vetrina orizzontale o verticale. La sua versatilità compositiva e la possibilità di integrare il sistema con sospensioni decorative lo rende indispensabile anche per il design della luce domestica, dove la luce accoglie e risolve.

Ermes is designed for any context where light reveals itself discreetly, perfect for the world of art and retail, it integrates into any type of horizontal or vertical showcase. Its compositional versatility and the possibility of integrating the system with decorative suspensions also makes it indispensable for designing domestic lighting, where light welcomes and solves.

modular suspension



PAGE 5



PAGE 7

spotlight



6W
PAGE 9



10W
PAGE 10



27W
PAGE 11

opal light line



PAGE 13



PAGE 14



PAGE 15



PAGE 16



PAGE 17

light line with optics



PAGE 19



PAGE 19

track



PAGE 20



PAGE 22

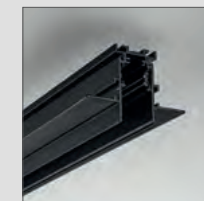

PAGE 24

modular suspension

This item can be used ON/OFF if the power supply 48V is ON/OFF and PUSH DIMMER if the power supply remoted 48V is PUSH DIMMER. Power supply 48V ON/OFF can be integrated in the track system powersupply 48V PUSH dimmer can be only remoted.

ermes 48V

ermes modular suspension

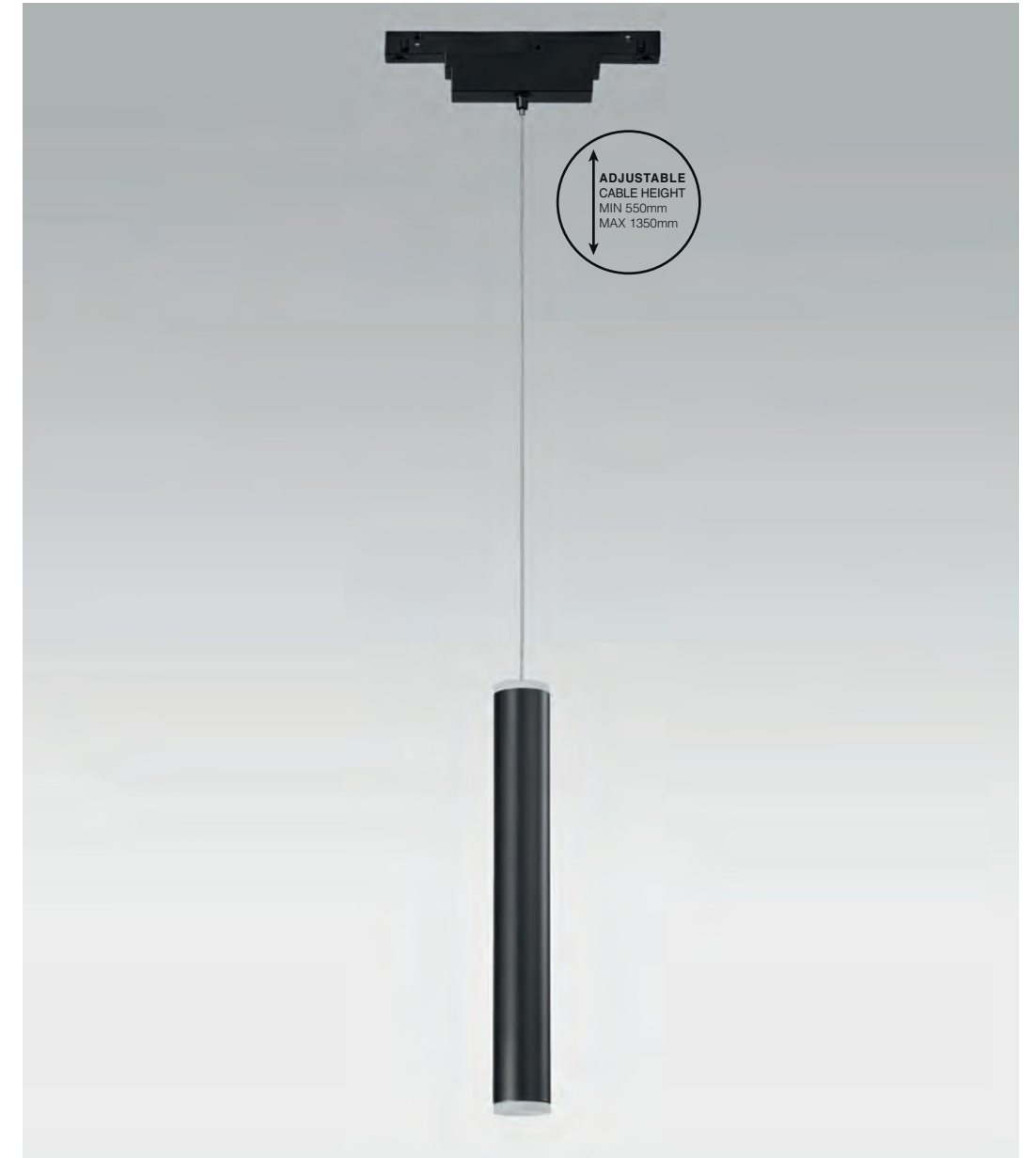

Input voltage	Led type	Operating amb. temp.	Net weight	Driver
48 VDC	SMD	-20° +40°C	0,30 Kg	Included

Code	Lenght mm	Finishing	Color temper.	Optic	CRI	Power Pack Type	Lm Source
6525-22-501	1300	White	3000K	diffuser	> 80	7,5W	720
6525-22-601	1300	Black	3000K	diffuser	> 80	7,5W	720

Driver Code	Finishing	Dimensions mm	Power	Power Pack Type
6301-08-012	Black	H 44 x 268	48V 250W Costant Voltage Driver	ON/OFF
6301-08-013	Ivory	H 35 x 210	48V 75W Costant Voltage Driver	Dimmer Push
6301-08-014	Black	H 19 x 298	48V 100W Costant Voltage Driver	ON/OFF
6301-08-015	White	H 44 x 268	48V 250W Costant Voltage Driver	ON/OFF
6301-08-017	White	H 19 x 298	48V 100W Costant Voltage Driver	ON/OFF

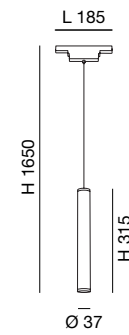

CE IP20 IK04

Energy Class: **A**
Years Warranty: **3**

modular suspension

This item can be used ON/OFF if the power supply 48V is ON/OFF and PUSH DIMMER if the power supply remoted 48V is PUSH DIMMER. Power supply 48V ON/OFF can be integrated in the track system powersupply 48V PUSH dimmer can be only remoted.

ermes 48V



ermes modular suspension

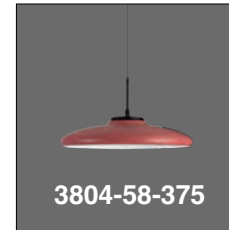
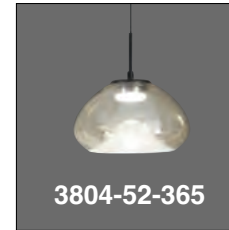

For other modular kits see catalogue

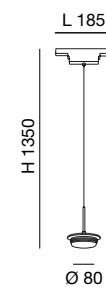
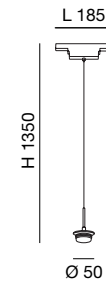

Input voltage	Led type	Operating amb. temp.	Net weight	Driver
48 VDC	SMD	-20° +40°C	0,18 Kg 0,31 Kg	Included

Code	Lenght mm	Finishing	Color temperature	Optic	CRI	Power Pack Type	Lm Source
6525-55-011	1300	White	2700/3000/4000K	diffuser	> 80	8W	750
6525-55-012	1300	White	2700/3000/4000K	diffuser	> 80	14W	1510
6525-56-011	1300	Black	2700/3000/4000K	diffuser	> 80	8W	750
6525-56-012	1300	Black	2700/3000/4000K	diffuser	> 80	14W	1510

Driver Code	Finishing	Dimensions mm	Power	Power Pack Type
6301-08-012	Black	H 44 x 268	48V 250W Costant Voltage Driver	ON/OFF
6301-08-013	Ivory	H 35 x 210	48V 75W Costant Voltage Driver	Dimmer Push
6301-08-014	Black	H 19 x 298	48V 100W Costant Voltage Driver	ON/OFF
6301-08-015	White	H 44 x 268	48V 250W Costant Voltage Driver	ON/OFF
6301-08-017	White	H 19 x 298	48V 100W Costant Voltage Driver	ON/OFF

spotlight 6W-10W-27W

ermes 48V



ermes spotlight 6W



Input voltage	Led type	Operating amb. temp.	Net weight	Driver
48 VDC	COB	-20° +40°C	0,12 Kg	Included

Code	Finishing	Power	Color temper.	Beam	CRI	Power Pack Type	Lm Source
6525-72-253	White	6W	3000K	16°	> 90	ON-OFF	530
6525-72-256	White	6W	3000K	16°	> 90	DALI	530
6525-72-263	Black	6W	3000K	16°	> 90	ON-OFF	530
6525-72-266	Black	6W	3000K	16°	> 90	DALI	530
6525-73-253	White	6W	2700K	16°	> 90	ON-OFF	500
6525-73-256	White	6W	2700K	16°	> 90	DALI	500
6525-73-263	Black	6W	2700K	16°	> 90	ON-OFF	500
6525-73-266	Black	6W	2700K	16°	> 90	DALI	500
6525-72-353	White	6W	3000K	24°	> 90	ON-OFF	530
6525-72-356	White	6W	3000K	24°	> 90	DALI	530
6525-72-363	Black	6W	3000K	24°	> 90	ON-OFF	530
6525-72-366	Black	6W	3000K	24°	> 90	DALI	530
6525-73-353	White	6W	2700K	24°	> 90	ON-OFF	500
6525-73-356	White	6W	2700K	24°	> 90	DALI	500
6525-73-363	Black	6W	2700K	24°	> 90	ON-OFF	500
6525-73-366	Black	6W	2700K	24°	> 90	DALI	500
6525-72-453	White	6W	3000K	34°	> 90	ON-OFF	530
6525-72-456	White	6W	3000K	34°	> 90	DALI	530
6525-72-463	Black	6W	3000K	34°	> 90	ON-OFF	530
6525-72-466	Black	6W	3000K	34°	> 90	DALI	530
6525-73-453	White	6W	2700K	34°	> 90	ON-OFF	500
6525-73-456	White	6W	2700K	34°	> 90	DALI	500
6525-73-463	Black	6W	2700K	34°	> 90	ON-OFF	500
6525-73-466	Black	6W	2700K	34°	> 90	DALI	500

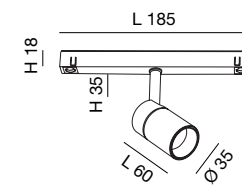

CE IP20 IK04

Energy Class **A** **E** 3 Years Warranty

ermes spotlight 10W



Input voltage	Led type	Operating amb. temp.	Net weight	Driver
48 VDC	COB	-20° +40°C	0,19 Kg	Included

Code	Finishing	Power	Color temper.	Beam	CRI	Power Pack Type	Lm Source
6525-82-253	White	10W	3000K	14°	> 90	ON-OFF	815
6525-82-256	White	10W	3000K	14°	> 90	DALI	815
6525-82-263	Black	10W	3000K	14°	> 90	ON-OFF	815
6525-82-266	Black	10W	3000K	14°	> 90	DALI	815
6525-83-253	White	10W	2700K	14°	> 90	ON-OFF	770
6525-83-256	White	10W	2700K	14°	> 90	DALI	770
6525-83-263	Black	10W	2700K	14°	> 90	ON-OFF	770
6525-83-266	Black	10W	2700K	14°	> 90	DALI	770
6525-82-453	White	10W	3000K	32°	> 90	ON-OFF	815
6525-82-456	White	10W	3000K	32°	> 90	DALI	815
6525-82-463	Black	10W	3000K	32°	> 90	ON-OFF	815
6525-82-466	Black	10W	3000K	32°	> 90	DALI	815
6525-83-453	White	10W	2700K	32°	> 90	ON-OFF	770
6525-83-456	White	10W	2700K	32°	> 90	DALI	770
6525-83-463	Black	10W	2700K	32°	> 90	ON-OFF	770
6525-83-466	Black	10W	2700K	32°	> 90	DALI	770
6525-82-653	White	10W	3000K	56°	> 90	ON-OFF	815
6525-82-656	White	10W	3000K	56°	> 90	DALI	815
6525-82-663	Black	10W	3000K	56°	> 90	ON-OFF	815
6525-82-666	Black	10W	3000K	56°	> 90	DALI	815
6525-83-653	White	10W	2700K	56°	> 90	ON-OFF	770
6525-83-656	White	10W	2700K	56°	> 90	DALI	770
6525-83-663	Black	10W	2700K	56°	> 90	ON-OFF	770
6525-83-666	Black	10W	2700K	56°	> 90	DALI	770

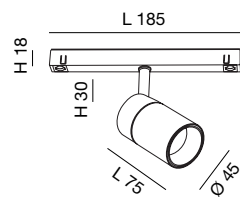

CE IP20 IK04 Energy Class **A** **E** 3 Years Warranty

ermes spotlight 27W



Input voltage	Led type	Operating amb. temp.	Net weight	Driver
48 VDC	COB	-20° +40°C	0,52 Kg	Included

Code	Finishing	Power	Color temper.	Beam	CRI	Power Pack Type	Lm Source
6525-92-253	White	27W	3000K	16°	> 90	ON-OFF	2820
6525-92-256	White	27W	3000K	16°	> 90	DALI	2820
6525-92-263	Black	27W	3000K	16°	> 90	ON-OFF	2820
6525-92-266	Black	27W	3000K	16°	> 90	DALI	2820
6525-93-253	White	27W	2700K	16°	> 90	ON-OFF	2700
6525-93-256	White	27W	2700K	16°	> 90	DALI	2700
6525-93-263	Black	27W	2700K	16°	> 90	ON-OFF	2700
6525-93-266	Black	27W	2700K	16°	> 90	DALI	2700
6525-92-553	White	27W	3000K	43°	> 90	ON-OFF	2820
6525-92-556	White	27W	3000K	43°	> 90	DALI	2820
6525-92-563	Black	27W	3000K	43°	> 90	ON-OFF	2820
6525-92-566	Black	27W	3000K	43°	> 90	DALI	2820
6525-93-553	White	27W	2700K	43°	> 90	ON-OFF	2700
6525-93-556	White	27W	2700K	43°	> 90	DALI	2700
6525-93-563	Black	27W	2700K	43°	> 90	ON-OFF	2700
6525-93-566	Black	27W	2700K	43°	> 90	DALI	2700

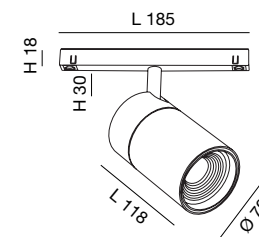

CE IP20 IK04 Energy Class **A** **D** **A** **E** 3 Years Warranty

opal light line

ermes 48V



ermes opal light line



Input voltage	Led type	Operating amb. temp.	Net weight	Driver	Power
48 VDC	SMD	-20° +40°C	0,17 Kg	Included	12W

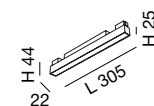

Code	Lenght mm	Finishing	Color temper.	Optic	CRI	Power Pack Type	Lm Source
6525-62-363	305	Black	3000K	Diffuser	> 90	ON-OFF	1260
6525-62-366	305	Black	3000K	Diffuser	> 90	DALI	1260
6525-63-363	305	Black	2700K	Diffuser	> 90	ON-OFF	1170
6525-63-366	305	Black	2700K	Diffuser	> 90	DALI	1170

IP20 IK04

ermes opal light line



Input voltage	Led type	Operating amb. temp.	Net weight	Driver	Power
48 VDC	SMD	-20° +40°C	0,29 Kg	Included	18W

ermes 48V

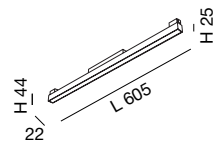

Code	Lenght mm	Finishing	Color temper.	Optic	CRI	Power Pack Type	Lm Source
6525-62-663	605	Black	3000K	Diffuser	> 90	ON-OFF	2168
6525-62-666	605	Black	3000K	Diffuser	> 90	DALI	2168
6525-63-663	605	Black	2700K	Diffuser	> 90	ON-OFF	2016
6525-63-666	605	Black	2700K	Diffuser	> 90	DALI	2016

IP20 IK04

ermes opal light line



Input voltage	Led type	Operating amb. temp.	Net weight	Driver	Power
48 VDC	SMD	-20° +40°C	0,56 Kg	Included	36W

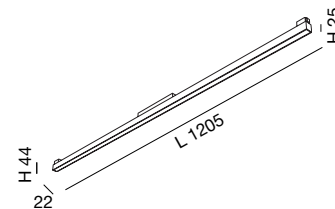

Code	Lenght mm	Finishing	Color temper.	Optic	CRI	Power Pack Type	Lm Source
6525-62-163	1205	Black	3000K	Diffuser	> 90	ON-OFF	4336
6525-62-166	1205	Black	3000K	Diffuser	> 90	DALI	4336
6525-63-163	1205	Black	2700K	Diffuser	> 90	ON-OFF	4032
6525-63-166	1205	Black	2700K	Diffuser	> 90	DALI	4032

IP20 IK04

ermes opal light line

ermes 48V



Input voltage	Led type	Operating amb. temp.	Net weight	Driver	Power
48 VDC	SMD	-20° +40°C	0,32 Kg	Included	22W

ermes opal light line



Input voltage	Led type	Operating amb. temp.	Net weight	Driver	Power
48 VDC	SMD	-20° +40°C	0,32 Kg	Included	22W

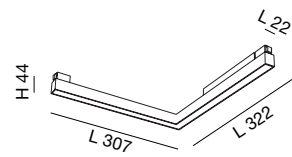

Code	Angle	Finishing	Color temper.	Optic	CRI	Power Pack Type	Lm Source
6525-42-163	External	Black	3000K	Diffuser	> 90	ON-OFF	2520
6525-42-166	External	Black	3000K	Diffuser	> 90	DALI	2520
6525-43-163	External	Black	2700K	Diffuser	> 90	ON-OFF	2340
6525-43-166	External	Black	2700K	Diffuser	> 90	DALI	2340

IP20 IK04

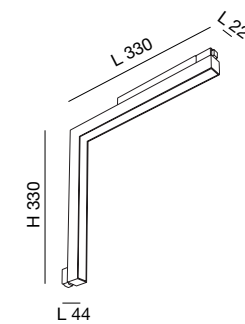

Code	Angle	Finishing	Color temper.	Optic	CRI	Power Pack Type	Lm Source
6525-42-263	Internal	Black	3000K	Diffuser	> 90	ON-OFF	2520
6525-42-266	Internal	Black	3000K	Diffuser	> 90	DALI	2520
6525-43-263	Internal	Black	2700K	Diffuser	> 90	ON-OFF	2340
6525-43-266	Internal	Black	2700K	Diffuser	> 90	DALI	2340

IP20 IK04

light line with optics

ermes 48V

ermes light line with optics

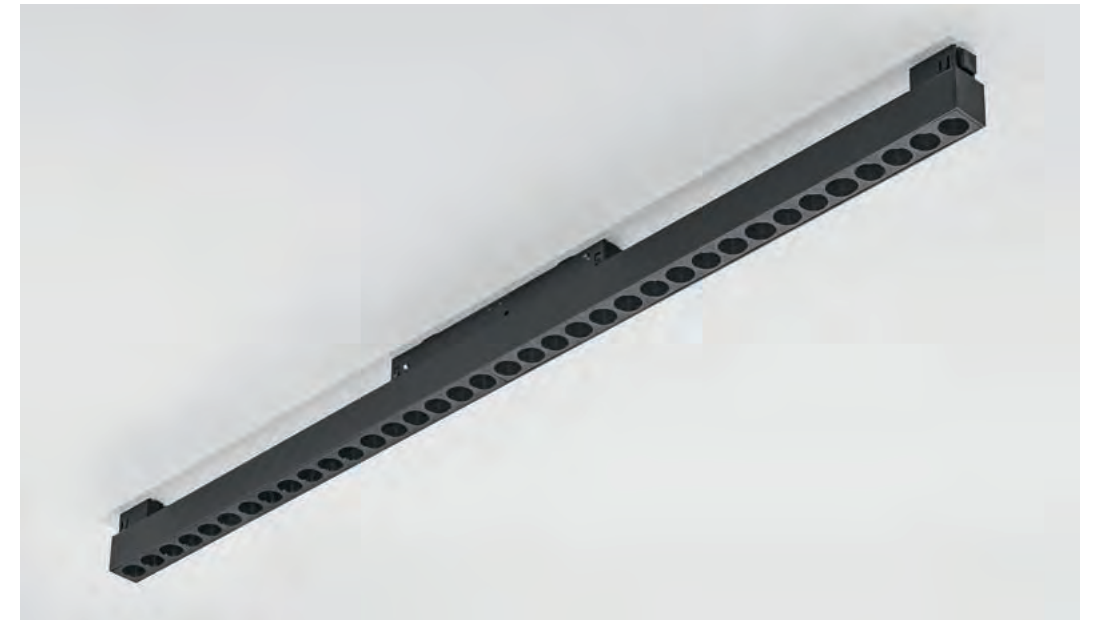

Input voltage	Led type	Operating amb. temp.	Net weight	Driver
48 VDC	SMD	-20° +40°C	0,21 Kg 0,40 Kg	Included

Code	Lenght mm	Finishing	Color temper.	Beam	CRI	Power Pack Type	Power	Lm Source
6525-32-363	328	Black	3000K	24°	> 90	ON-OFF	18W	1800
6525-32-366	328	Black	3000K	24°	> 90	DALI	18W	1800
6525-33-363	328	Black	2700K	24°	> 90	ON-OFF	18W	1720
6525-33-366	328	Black	2700K	24°	> 90	DALI	18W	1720

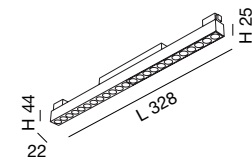

Code	Lenght mm	Finishing	Color temper.	Beam	CRI	Power Pack Type	Power	Lm Source
6525-32-663	652	Black	3000K	24°	> 90	ON-OFF	36W	3600
6525-32-666	652	Black	3000K	24°	> 90	DALI	36W	3600
6525-33-663	652	Black	2700K	24°	> 90	ON-OFF	36W	3440
6525-33-666	652	Black	2700K	24°	> 90	DALI	36W	3440

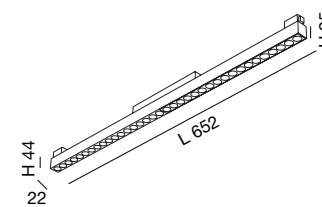

track H27,4

ermes 48V



Input voltage	Led type	Operating amb. temp.	Net weight
48 VDC	-	-	0,70 Kg/m

Code	Finishing	Height mm	Lenght mm	Cover end caps
6525-05-110	White	27,4	1000	Included
6525-05-120	White	27,4	2000	Included
6525-05-130	White	27,4	3000	Included
6525-06-110	Black	27,4	1000	Included
6525-06-120	Black	27,4	2000	Included
6525-06-130	Black	27,4	3000	Included

CE IP20 IK06

3
Years
Warranty

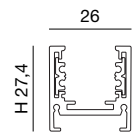

ermes track H27,4 - Accessories and Driver

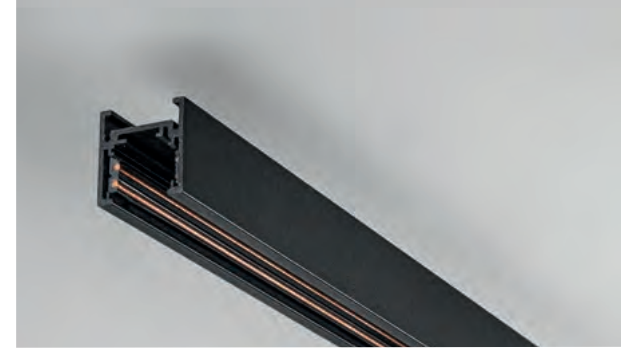

ACCESSORIES	Code	Finishing	Dimensions mm	Description
	6525-05-100	White	65 x 65 x 27,4	L joint
	6525-06-100	Black		
	6525-50-001	Black	L 80 x 23 x H 6	Mechanical feed
	6525-55-001	White	26 x 21	End cap kit
	6525-56-001	Black		
	6525-55-005	White	25 x 3000	Cover
	6525-56-005	Black		
	6525-55-006	White	L 81 x H 18	Power feeder unit
	6525-56-006	Black		
	6525-55-007	White	L 83 x H 18	Linear joint feed
	6525-56-007	Black		
	6525-55-008	White	130 x 130 x H 18	Flexible joint feed
	6525-56-008	Black		
	6525-55-009	White	Ø 50 x 20 2 mt. steel wire	Suspension kit
	6525-56-009	Black		
	6525-55-010	White	80 x 80 x 22	Ceiling cup for suspension kit
	6525-56-010	Black		

DRIVER	Code	Finishing	Dimensions mm	Power	Power Pack Type
	6301-08-012	Black	H 44 x 268	48V 250W Constant Voltage Driver	ON/OFF
	6301-08-015	White			
	6301-08-014	Black	H 19 x 298	48V 100W Constant Voltage Driver	ON/OFF
	6301-08-017	White			

track H54

ermes 48V



Input voltage	Led type	Operating amb. temp.	Net weight
48 VDC	-	-	1,00 Kg/m

Code	Finishing	Height mm	Lenght mm	Cover end caps
6525-05-210	White	54	1000	Included
6525-05-220	White	54	2000	Included
6525-05-230	White	54	3000	Included
6525-06-210	Black	54	1000	Included
6525-06-220	Black	54	2000	Included
6525-06-230	Black	54	3000	Included



CE  IP20 IK06

 3
Years
Warranty

ermes track H54 - Accessories and Driver



ACCESSORIES	Code	Finishing	Dimensions mm	Description
	6525-05-200	White	65 x 65 x 54	L joint
	6525-06-200	Black		
	6525-50-001	Black	L 80 x 23 x H 6	Mechanical feed
	6525-55-002	White	26 x 52	End cap kit
	6525-56-002	Black		
	6525-55-004	White	24 x 3000	Cover
	6525-56-004	Black		
	6525-55-006	White	L 81 x H 18	Power feeder unit
	6525-56-006	Black		
	6525-55-007	White	L 83 x H 18	Linear joint feed
	6525-56-007	Black		
	6525-55-008	White	130 x 130 x H 18	Flexible joint feed
	6525-56-008	Black		
	6525-55-009	White	Ø 50 x 20 2 mt. steel wire	Suspension kit
	6525-56-009	Black		
	6525-55-010	White	80 x 80 x 22	Ceiling cup for suspension kit
	6525-56-010	Black		

DRIVER	Code	Finishing	Dimensions mm	Power	Power Pack Type
	6301-08-012	Black	H 44 x 268	48V 250W Constant Voltage Driver	ON/OFF
	6301-08-015	White			
	6301-08-014	Black	H 19 x 298	48V 100W Constant Voltage Driver	ON/OFF
	6301-08-017	White			

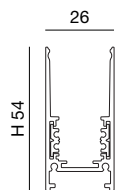

track recessed

ermes 48V

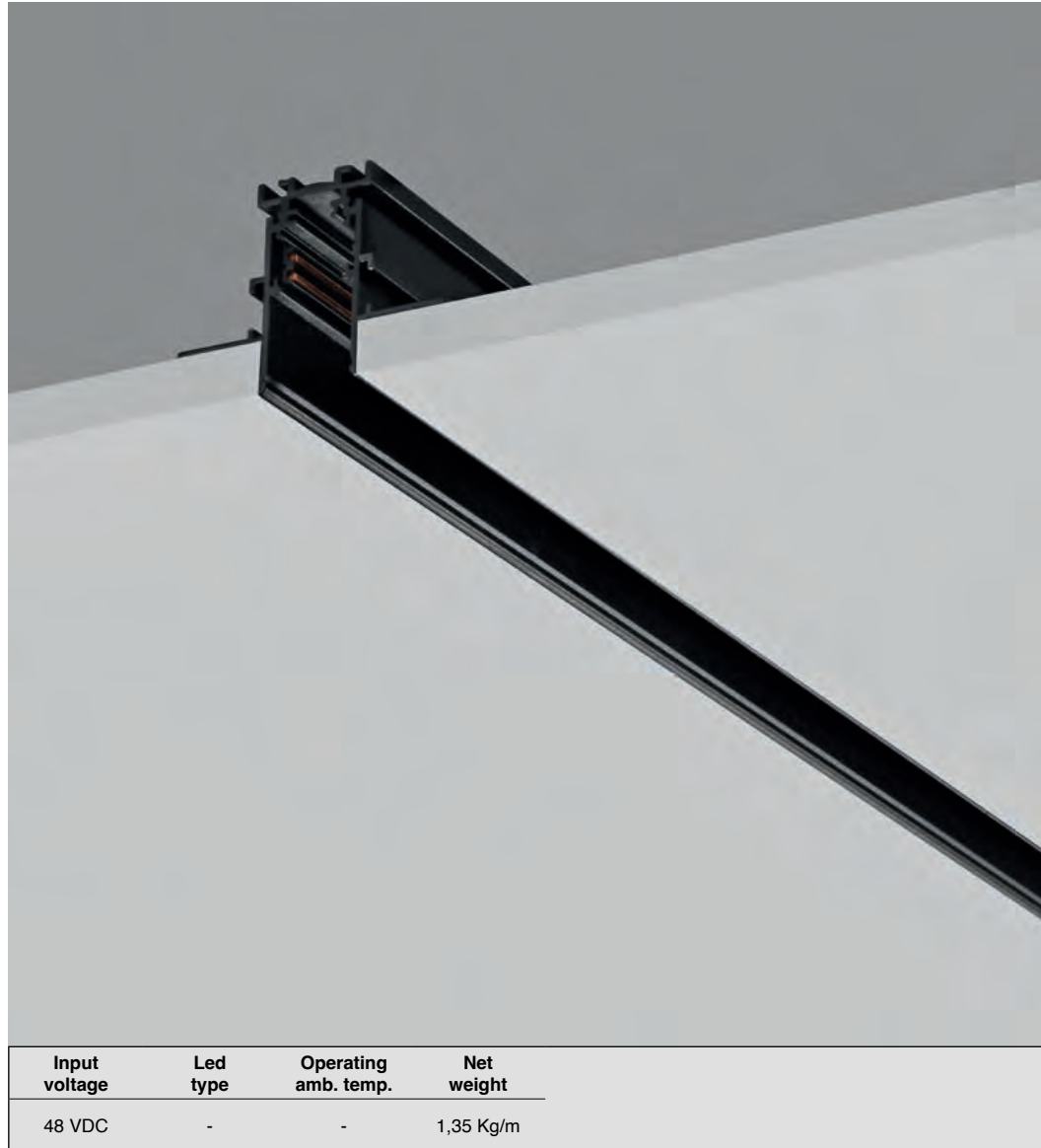

Input voltage	Led type	Operating amb. temp.	Net weight
48 VDC	-	-	1,35 Kg/m

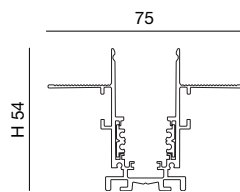

Code	Finishing	Height mm	Lenght mm	Cover end caps
6525-05-310	White	54	1000	Included
6525-05-320	White	54	2000	Included
6525-05-330	White	54	3000	Included
6525-06-310	Black	54	1000	Included
6525-06-320	Black	54	2000	Included
6525-06-330	Black	54	3000	Included

CE IP20 IK06

3
Years
Warranty

ermes track recessed - Accessories and Driver

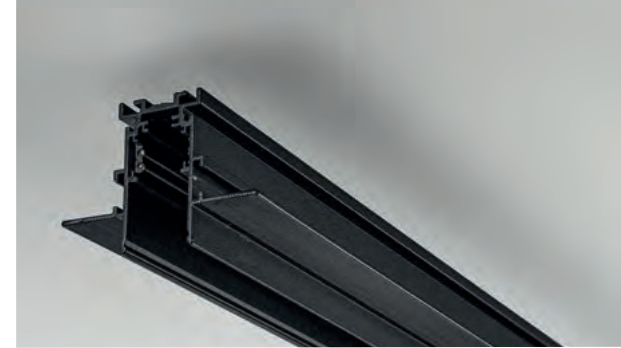

ACCESSORIES	Code	Finishing	Dimensions mm	Description
	6525-05-300	White	65 x 65 x 54	L joint
	6525-06-300	Black		
	6525-50-002	Black	L 80 x 13 x H 4	Mechanical feed
	6525-55-003	White	26 x 54	End cap kit
	6525-56-003	Black		
	6525-55-004	White	24 x 3000	Cover
	6525-56-004	Black		
	6525-55-006	White	L 81 x H 18	Power feeder unit
	6525-56-006	Black		
	6525-55-007	White	L 83 x H 18	Linear joint feed
	6525-56-007	Black		
	6525-55-008	White	130 x 130 x H 18	Flexible joint feed
	6525-56-008	Black		

DRIVER	Code	Finishing	Dimensions mm	Power	Power Pack Type
	6301-08-012	White	H 44 x 268	48V 250W Constant Voltage Driver	ON/OFF
	6301-08-015	Black			
	6301-08-014	White	H 19 x 298	48V 100W Constant Voltage Driver	ON/OFF
	6301-08-017	Black			

SYMBOLS EXPLANATION



All FABAS LUCE products fall within the range of application of the European electromagnetic compatibility E.M.C. directive 2014/30/UE and subsequent amendment and/or the European low voltage directive B.T. 2014/35/UE and subsequent, meet the required specifications and bear "CE" labelling.



Luminaire in which protection against electrical shocks is not just based on the basic insulation but also on an additional safety precautions consisting of connecting the accessible conductive parts to a safety conductor (earth), that is included in the electrical system.



Class II certified equipment, with double insulated wiring. During installation, cut earth wire.



A luminaire in which protection against electric shock relies on supply at safety extra-low voltage (SELV) and in which voltages higher than those of SELV are not generated.

IP20

Protected against solid objects greater than 12 mm.

IP44

Protected against solid objects greater than 1 mm and splashing water.

IP54

Protected against dust and splashing water.

IP65

Fully protected against dust and water jets.

IP67

Fully protected against dust and protected against continuous immersion.

IK	Impact in Joule	Tested weight	Drop height test
IK01	0,15	250 g	5,6 cm
IK02	0,20	250 g	8 cm
IK03	0,35	250 g	14 cm
IK04	0,50	250 g	20 cm
IK05	0,70	250 g	28 cm
IK06	1,00	250 g	40 cm
IK07	2,00	500 g	40 cm
IK08	5,00	1,7 kg	30 cm
IK09	10,00	5 kg	20 cm
IK10	20,00	5 kg	40 cm

Please note: Fabas Luce products are protected by design registrations and patents, imitations will be prosecuted. Place of delivery and jurisdiction for both parties is Monza (Italy). As a rule, only our sales and supply conditions will be applied. We reserve ownership rights to this catalogue. Delivery is ex works. All dimensions in this catalogue are in millimeters. While maintaining the basic characteristics of the product, the manufacturer reserves the right to make modifications at any time and without any prior notice, with the sole aim of improving the quality of the product.

Bulbs: Included in delivery only if declared as included (incl.) in product specifications. Bulbs are consumables and thus not subject to otherwise applicable defect warranty rights.

Spareparts: Are accessible on the website www.fabasluce.it.

Care information: Please only use a soft dry cotton cloth to clean the lamps. Please do not use cleaners or liquids. Please also read the instructions of use and assembly supplied with the lamps. We reserve the right to design modifications. The measurement specifications refer to approximate dimensions.

Retention of title: We reserve ownership rights of the delivered goods until complete payment of all receivables resulting from the contract. These conditions also apply to all future business relations even if this is not expressly agreed again. We are entitled to take back the goods if the buyer breaches the contract.

CONTACTS

FABAS LUCE S.p.A.
sede

Via Luigi Talamoni, 75
20861 Brugherio (MB) Italy
Tel. 0039 039 890 69 1
0039 039 214 22 06

Fax 0039 039 214 22 08
www.fabasluce.it
info@fabasluce.it
venditefabas@fabasluce.it
salesdept@fabasluce.it



FABAS LUCE GmbH

Westring, 5
D-59759 Arnsberg Germany
Tel. 0049 29 32 / 8 90 16 60
Fax 0049 29 32 / 8 90 16 62
vertrieb@fabasluce.com



CERTIFICATES



printed in Italy
February 2024

È VIETATA LA RIPRODUZIONE ANCHE
PARZIALE DI QUESTO CATALOGO.
IT IS FORBIDDEN TO REPRODUCE
ANY PART OF THIS CATALOGUE.



CAF2024-02



www.fabasluc.it